



Glow+

SALICE



Glow+ est un système coulissant pour armoires à 2, 3 (ou plus) portes superposées, équipé d'un amortisseur magnétique révolutionnaire, qui permet l'ouverture et la fermeture des portes en douceur, d'une manière progressive et silencieuse.

Cette solution innovante élimine définitivement le bruit de fonctionnement et la résistance à l'ouverture typiquement produits par les amortisseurs traditionnels à ressort.

Glow+ peut être utilisé aussi bien avec des portes en bois que des portes à cadre en aluminium, avec un poids max. de 70 kg.

Avec l'utilisation d'un kit de renforcement supplémentaire, le système peut être utilisé avec des portes jusqu'à 100 kg.

L'assemblage du Glow + est très facile et intuitif. Il peut être installé avec des vis ou automatiquement avec des clips à frapper.

Le système peut être équipé d'un cache magnétique qui apporte en plus une amélioration esthétique.

Glow + peut être utilisé dans bien des cas de figures différents, particulièrement dans des salles de séjour et dans les chambres à coucher.





Informations techniques

COMPOSITION DU MÉCANISME

- Profilés en aluminium : alliage 6060T5, anodisés argent.
- Galets de coulissement : roulements pour grande vitesse.
- Ferrures de coulissement : supérieurs et inférieurs : pièce en métal peinte.
- Composants internes : plastique et zamak.

CARACTÉRISTIQUES DES PORTES

- Poids maximum par porte 70 kg.
Avec kit de renforcement 100 kg (Réparti de manière uniforme).
- Épaisseur subdivisée en 6 catégories :
 - 1: jusqu'à 23 mm ;
 - 2: jusqu'à 26 mm ;
 - 3: jusqu'à 30 mm ;
 - 4: jusqu'à 35 mm ;
 - 5: jusqu'à 40 mm ;
 - 6: jusqu'à 50 mm.
- Hauteur du sol : 17 mm ou 33 mm.
- Matériaux :
 - a) bois ou produits dérivés ;
 - b) cadre en métal ou en verre.
- Largeur minimale pour la mise en place de l'amortisseur :
 - 2 portes 600 mm ;
 - 3 portes 830 mm ;
 - 2 et 3 portes avec kit de renforcement 1000 mm.
- Réglage de la porte : vertical +5/-0 mm.

TYPES D'OUVERTURES

- Glow+ est disponible à une, deux, trois ou plusieurs portes, chacune amortie tant en fermeture qu'en ouverture.



Caractéristiques principales

Amortisseur innovant à fonctionnement magnétique fluide et silencieux.

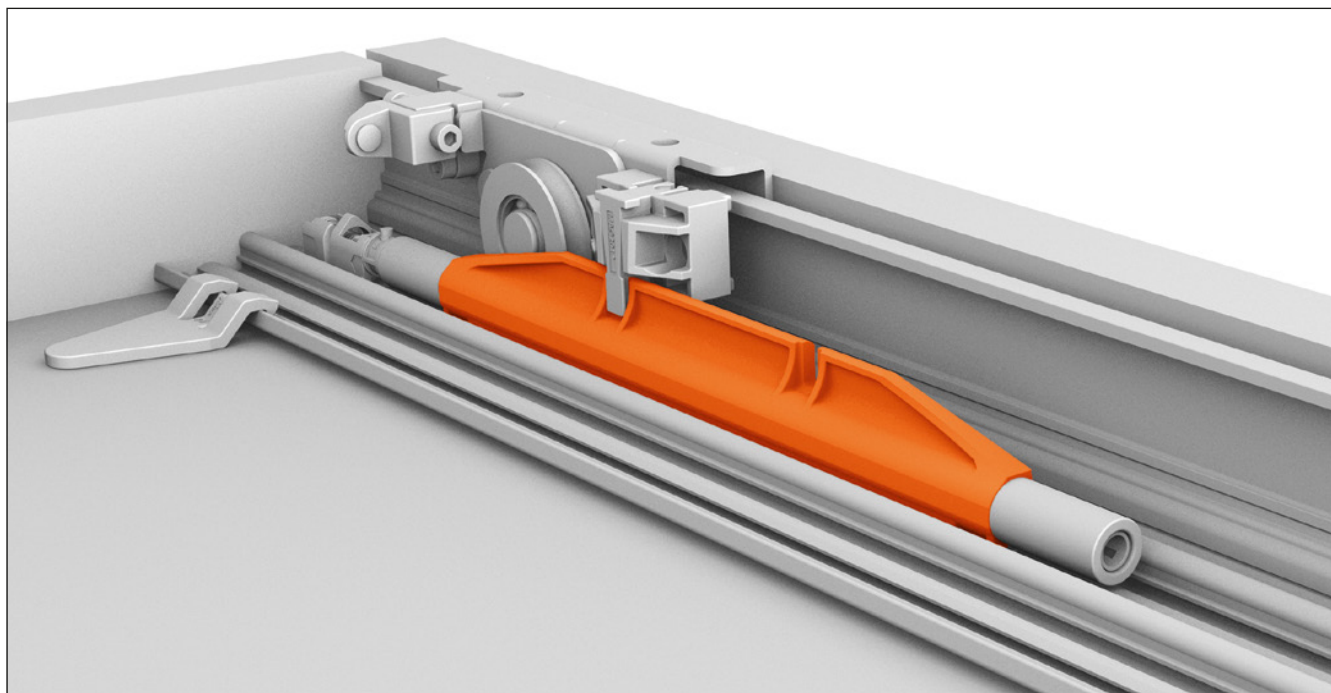

Butées extrêmement faciles à monter et à repositionner.

Accrochage automatique, avec réarmement, entre la ferrure de coulissement et l'amortisseur.

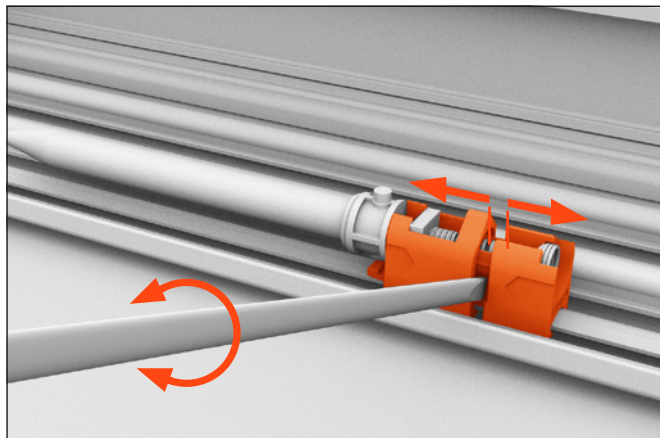

Cache frontal du mécanisme à accrochage magnétique.

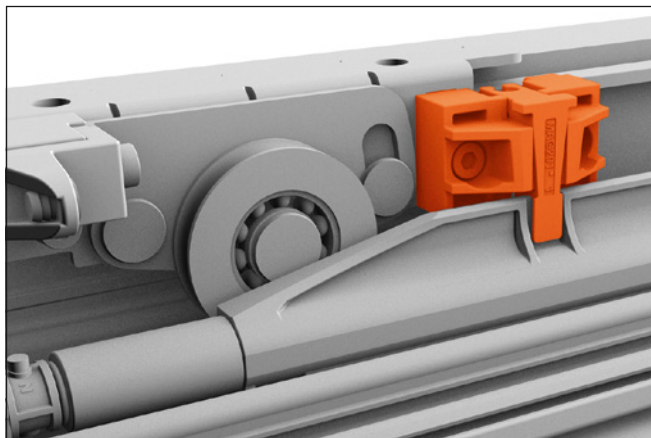

Installation des rails par simple clipsage sur clips insérés par pression.

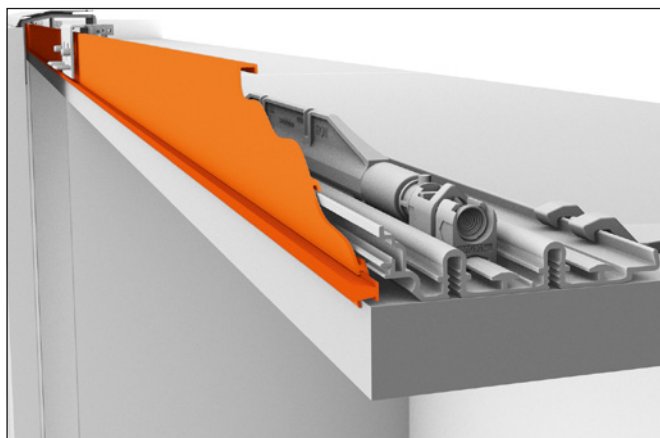

Glow Montageart

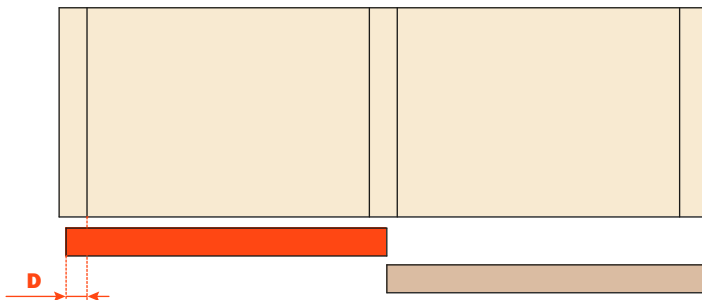
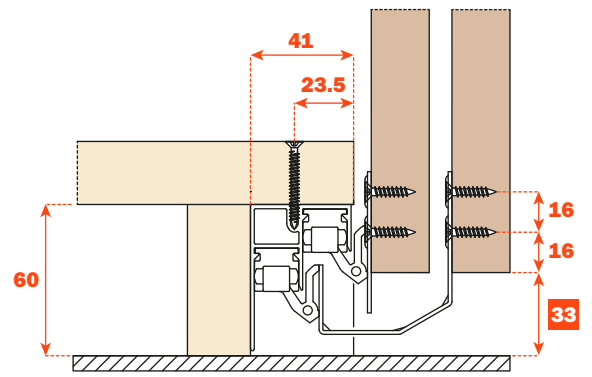
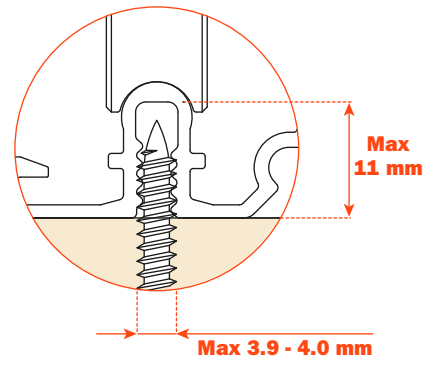
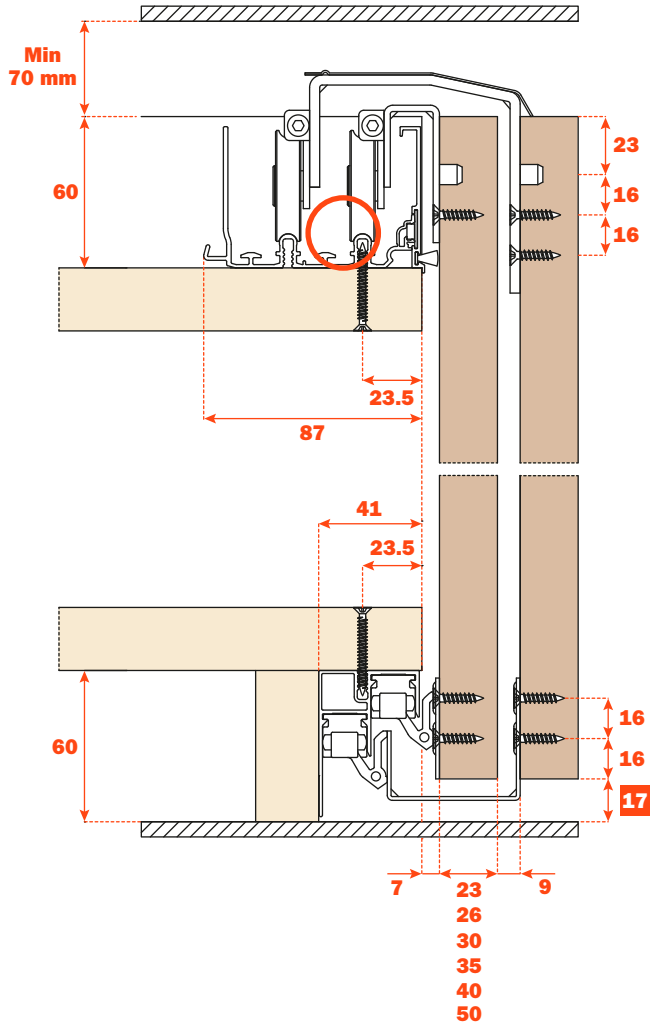

A min = D + 41 mm

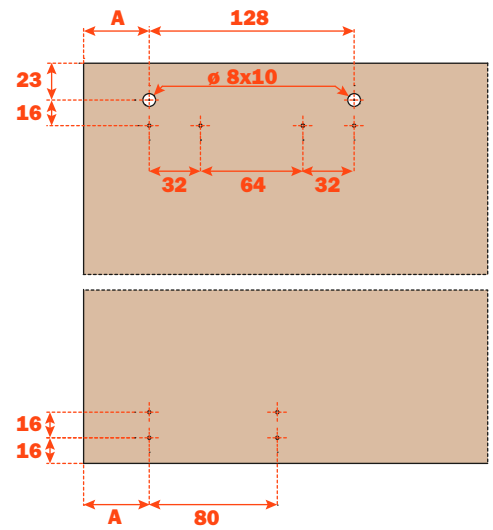

Klik

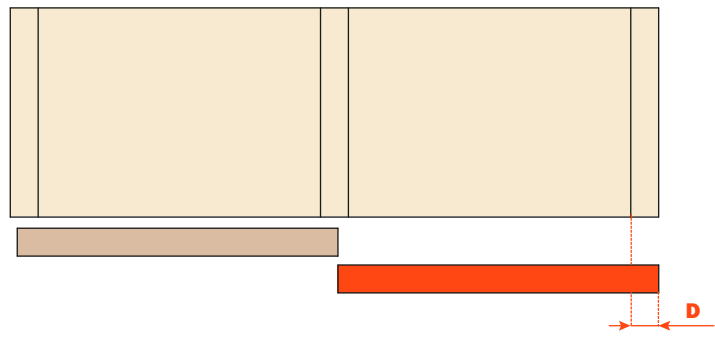
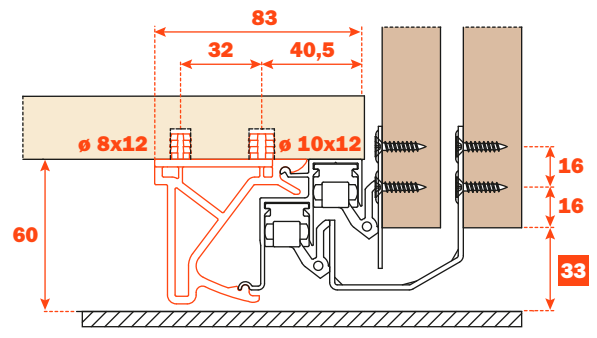
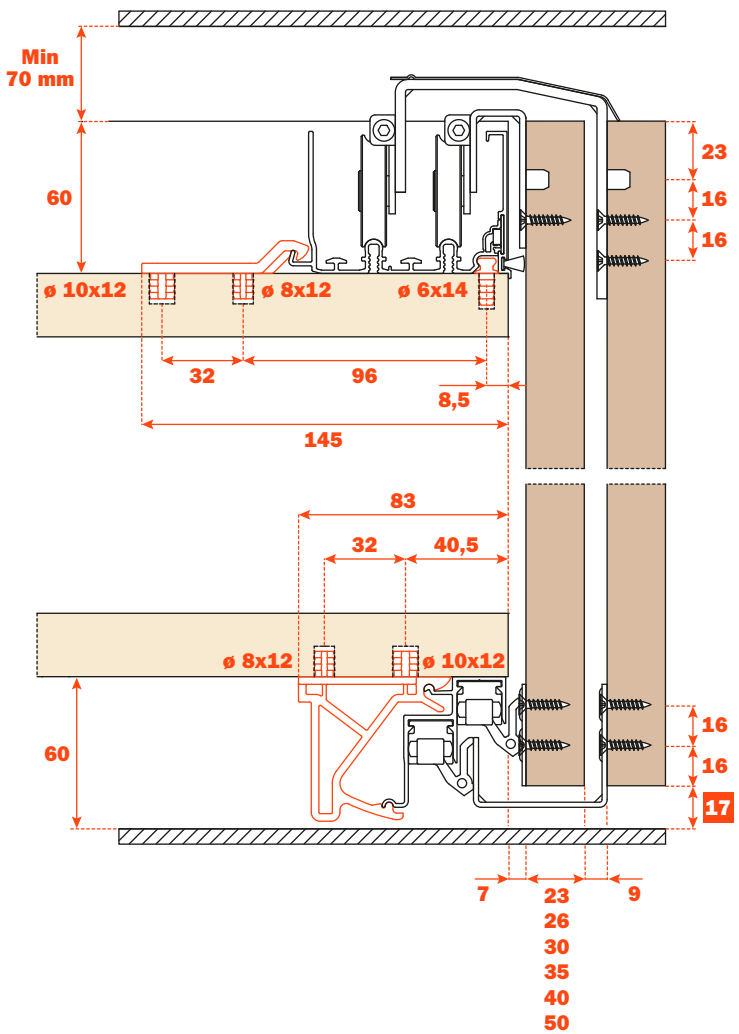



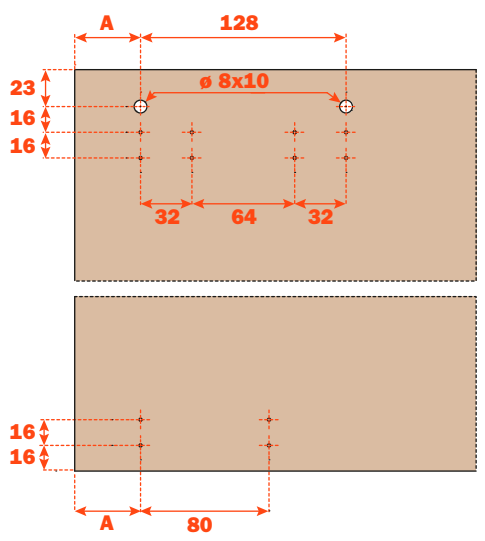













$A \text{ min} = D + 41 \text{ mm}$





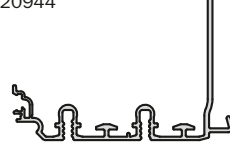

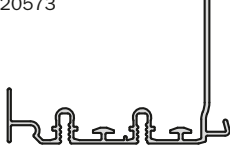



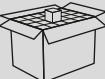

Glow Comment commander les emballages par article

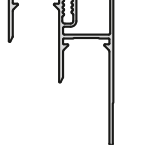
RAILS COULISSANTS

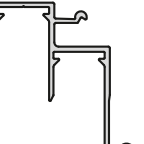





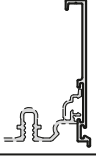
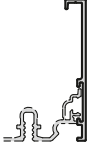

RAIL HAUT STANDARD	L	CODE ARTICLE	 pièces	 Kg	 mm	FIXATION	
	mm						
Prévu pour le cache frontal	6200	VE41PIA16200AB	8	39,0	105 x 115 x 6300	Klik 	21152 
	3100	VE41PTA13100AB	8	19,6	105 x 115 x 3200	Klik 	
Non prévu pour le cache frontal	6200	VE41PIB16200AB	8	39,5	105 x 115 x 6300	Klik 	21151 
	3100	VE41PTB13100AB	8	19,8	105 x 115 x 3200	Klik 	

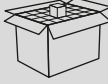
RAIL HAUT RENFORCÉ	L	CODE ARTICLE	 pièces	 Kg	 mm	FIXATION	
	mm						
Prévu pour le cache frontal	6200	VE41PIA26200AB	8	52,4	200 x 130 x 6300	Klik 	20944 
	3100	VE41PTA23100AB	8	26,2	200 x 130 x 3200	Klik 	
Non prévu pour le cache frontal	6200	VE41PIB26200AB	8	52,6	200 x 130 x 6300	Klik 	20573 
	3100	VE41PTB23100AB	8	26,3	200 x 130 x 3200	Klik 	

RAIL BAS	L	CODE ARTICLE	 pièces	 Kg	 mm	FIXATION	
	mm						
	6200	VE41PIE16200AB	8	37,0	75 x 190 x 6300		21162 
	3100	VE41PTE13100AB	8	18,5	75 x 190 x 3200		
	6200	VE41BIX06200AB	8	35,8	235 x 75 x 6300	Klik	39428 
	3100	VE41BTX03100AB	8	17,9	235 x 75 x 3200	Klik	













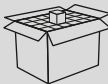

CACHE FRONTAL	L	CODE ARTICLE	 pièces	 Kg	 mm		
	mm						
Avec rainure pour le joint brosse	6200	VE41BIA06200AB	8	15,7	125 x 75 x 6300		34032 
	3100	VE41BTA03100AB	8	7,80	125 x 75 x 3200		
Sans rainure pour le joint brosse	6200	VE41BIB06200AB	8	15,02	125 x 75 x 6300		35510 
	3100	VE41BTB03100AB	8	7,50	125 x 75 x 3200		













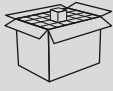



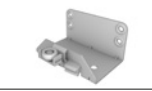

FERRURES DE COULISSEMENT POUR PORTE INTERIEURE

ARTICLE		CODE ARTICLE	 pièces	 Kg	 m ³	 mm	
	mm						
Ferrure de coulissement haut droit		VE41KMCMi350DX0	30	13,0	0,016	445 x 191 x 190	
Ferrure de coulissement haut gauche		VE41KMCMi350SX0	30	13,0	0,016	445 x 191 x 190	
Ferrure de coulissement bas	17	VE41KMGLW310	30	2,9	0,008	295 x 292 x 100	
	33	VE41KMGLW320	30	3,6	0,008	295 x 292 x 100	

Glow Comment commander les emballages par article











FERRURES DE COULISSEMENT POUR PORTE EXTERIEURE

ARTICLE	 mm	 mm	CODE ARTICLE	 pièces	 Kg	 m ³	 mm	
Ferrure de coulissement haut droit	≤ 23		VE41KMCM1370DX0	30	30,0	0,038	460 x 460 x 180	
Ferrure de coulissement haut gauche	≤ 23		VE41KMCM1370SX0	30	30,0	0,038	460 x 460 x 180	
Ferrure de coulissement bas	≤ 23	17	VE41KMGLW311	30	6,3	0,011	330 x 310 x 110	
	≤ 23	33	VE41KMGLW321	30	6,8	0,011	330 x 310 x 110	
Ferrure de coulissement haut droit	≤ 26		VE41KMCM1375DX0	30	30,5	0,038	460 x 460 x 180	
Ferrure de coulissement haut gauche	≤ 26		VE41KMCM1375SX0	30	30,5	0,038	460 x 460 x 180	
Ferrure de coulissement bas	≤ 26	17	VE41KMGLW316	30	6,5	0,011	330 x 310 x 110	
	≤ 26	33	VE41KMGLW326	30	6,9	0,011	330 x 310 x 110	

















ARTICLE	 mm	 mm	CODE ARTICLE	 pièces	 Kg	 m ³	 mm	
Ferrure de coulissement haut droit	≤ 30		VE41KMCMi371DX0	30	31,0	0,038	460 x 460 x 180	
Ferrure de coulissement haut gauche	≤ 30		VE41KMCMi371SX0	30	31,0	0,038	460 x 460 x 180	
Ferrure de coulissement bas	≤ 30	17	VE41KMGLW312	30	6,7	0,011	330 x 310 x 110	
	≤ 30	33	VE41KMGLW322	30	7,1	0,011	330 x 310 x 110	
Ferrure de coulissement haut droit	≤ 35		VE41KMCMi372DX0	30	32,0	0,043	530 x 460 x 180	
Ferrure de coulissement haut gauche	≤ 35		VE41KMCMi372SX0	30	32,0	0,043	530 x 460 x 180	
Ferrure de coulissement bas	≤ 35	17	VE41KMGLW313	30	7,0	0,022	390 x 310 x 190	
	≤ 35	33	VE41KMGLW323	30	7,4	0,022	390 x 310 x 190	
Ferrure de coulissement haut droit	≤ 40		VE41KMCMi374DX0	30	33,0	0,043	530 x 460 x 180	
Ferrure de coulissement haut gauche	≤ 40		VE41KMCMi374SX0	30	33,0	0,043	530 x 460 x 180	
Ferrure de coulissement bas	≤ 40	17	VE41KMGLW315	30	7,3	0,011	330 x 310 x 110	
	≤ 40	33	VE41KMGLW325	30	7,7	0,011	330 x 310 x 110	

Glow Comment commander les emballages par article

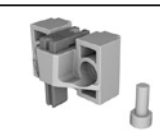
FERRURES DE COULISSEMENT POUR PORTE EXTERIEURE

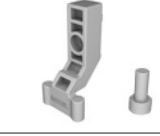









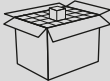

ARTICLE	 mm	 mm	CODE ARTICLE	 pièces	 Kg	 m ³	 mm	
Ferrure de coulissement haut droit	≤ 50		VE41KMCM1373DX0	30	34	0,043	530 x 460 x 180	
Ferrure de coulissement haut gauche	≤ 50		VE41KMCM1373SX0	30	34	0,043	530 x 460 x 180	
Ferrure de coulissement bas	≤ 50	17	VE41KMGLW314	30	7,7	0,022	390 x 310 x 110	
	≤ 50	33	VE41KMGLW324	30	8,1	0,022	390 x 310 x 110	

AMORTISSEUR ET BUTÉES

ARTICLE	CODE ARTICLE	 pièces	 Kg	 m ³	 mm	
Amortisseur magnétique 25 kg	VE41KMAMCMA0500	30	5,1	0,015	350 x 180 x 125	
Amortisseur magnétique 45 kg	VE41KMAMCMA1000	30	5,1	0,015	350 x 180 x 125	
Amortisseur magnétique 70 kg	VE41KMAMCMA2000	30	5,1	0,015	350 x 300 x 150	
Butée pour amortisseur magnétique 45 kg	VE41KMAMCMA5000	60	5,6	0,023	420 x 240 x 175	
Butée pour amortisseur magnétique 70 kg	VE41KMAMCMA5100	60	5,6	0,023	420 x 240 x 175	
Entraîneur pour amortisseur magnétique	VE41KMAMCMA3000	30	0,7	0,005	240 x 200 x 100	
Butée finale	VE41KMANCMI2000	60	2,4	0,003	140 x 140 x 140	
Déclencheur pour butée finale	VE41KMANCMI3000	30	1,6	-	120 x 80 x 40	
Butée inférieure	VE41KMGLW220	60	0,7	-	-	
Tige anti-collision	VE41KMGLW510	30	1,5	-	-	
Protège-poignée	VE41KMGLW230	30	0,1	-	-	

Glow Comment commander les emballages par article

ACCESSOIRES

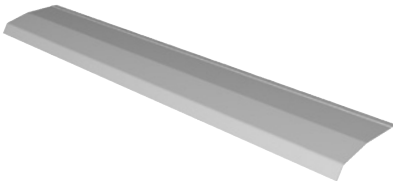
ARTICLE	L	CODE ARTICLE	 pièces	 Kg	 m ³	 mm	
	mm						
Goujon frontal		VE41MPGLW160	180	1,0	0,002	130 x 120 x 120	
CLIP supérieur		VE41MPGLW260	180	2,2	0,011	330 x 310 x 110	
CLIP inférieur		VE41MPGLW270.0	180	4,5	0,023	480 x 280 x 175	
Applicateur clip inférieur		VE41MPGLW271.0	30	1,2	0,005	250 x 200 x 100	
Contreplaque		VE41MPGLW330	200	1,2	-	120 x 80 x 40	
Aimant 25x6		VE41MPMA250603	200	0,6	-	120 x 80 x 40	
Joint brosse H7 grise		VE41MPPB4829	325 m	2,0	0,030	350 x 350 x 250	
Kit dispositifs antidéraillement (Droit+Gauche)		VE41MPGLW280	30	0,7	0,005	234 x 174 x 119	
Caches chariots de porte extérieure 	600	VE41CMVS00600A	10	4,3	0,003	100 x 50 x 600	
	700	VE41CMVS00700A	10	5,1	0,004	100 x 50 x 700	
	800	VE41CMVS00800A	10	5,8	0,004	100 x 50 x 800	
	900	VE41CMVS00900A	10	6,5	0,005	100 x 50 x 900	
	1000	VE41CMVS01000A	10	7,2	0,005	100 x 50 x 1000	
	1100	VE41CMVS01100A	10	7,9	0,006	100 x 50 x 1100	
	1200	VE41CMVS01200A	10	8,7	0,006	100 x 50 x 1200	
	1300	VE41CMVS01300A	10	9,4	0,007	100 x 50 x 1300	
	1400	VE41CMVS01400A	10	10,1	0,007	100 x 50 x 1400	
	1500	VE41CMVS01500A	10	10,8	0,008	100 x 50 x 1500	
	1600	VE41CMVS01600A	10	11,5	0,008	100 x 50 x 1600	
	1700	VE41CMVS01700A	10	12,3	0,009	100 x 50 x 1700	
	1800	VE41CMVS01800A	10	13,0	0,009	100 x 50 x 1800	
	1900	VE41CMVS01900A	10	13,7	0,010	100 x 50 x 1900	
2000	VE41CMVS02000A	10	14,4	0,010	100 x 50 x 2000		

Exemple 1

Armoire 2 portes de 900 mm, épaisseur 30 mm, H du sol 17 mm, rail standard, amortisseur, cache frontal avec joint brosse, rails de 3100 mm de longueur.

1 x VE41PTA13100AB	1 x VE41KMCMi350SX0	2 x VE41KMGLW312	4 x VE41KMGLW220	2 x VE41MPPB4829
1 x VE41PTE13100AB	2 x VE41KMGLW310	2 x VE41KMAMCMA1000	1 x VE41KMGLW230	1 x VE41CMVS00900A
1 x VE41BTA03100AB	1 x VE41KMCMi371DX0	4 x VE41KMAMCMA5000	5 x VE41MPGLW330	
1 x VE41KMCMi350DX0	1 x VE41KMCMi371SX0	2 x VE41KMAMCMA3000	5 x VE41MPMA250603	

Exemple 2

Armoire 3 portes de 1200 mm, épaisseur 35 mm, H du sol 33 mm, rail renforcé, amortisseur, cache frontal avec joint brosse, rails de 6200 mm de longueur.

1 x VE41PIA26200AB	2 x VE41KMCMi350SX0	2 x VE41KMGLW323	4 x VE41KMGLW220	4 x VE41MPPB4829
1 x VE41PIE16200AB	4 x VE41KMGLW320	3 x VE41KMAMCMA2000	2 x VE41KMGLW230	1 x VE41CMVS01200A
1 x VE41BIA06200AB	1 x VE41KMCMi372DX0	6 x VE41KMAMCMA5000	8 x VE41MPGLW330	
2 x VE41KMCMi350DX0	1 x VE41KMCMi372SX0	3 x VE41KMAMCMA3000	8 x VE41MPMA250603	

Exemple 3









Armoire 2 portes de 800 mm, épaisseur 23 mm, H du sol 17 mm, rail standard, sans amortisseur et sans cache frontal, rails de 3100 mm de longueur.

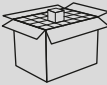







1 x VE41PTB13100AB	1 x VE41KMCMi350SX0	1 x VE41KMCMi370SX0	4 x VE41KMANCMI2000	1 x VE41KMGLW230
1 x VE41PTE13100AB	2 x VE41KMGLW310	2 x VE41KMGLW311	2 x VE41KMANCMI3000	1 x VE41CMVS00800A
1 x VE41KMCMi350DX0	1 x VE41KMCMi370DX0		4 x VE41KMGLW220	





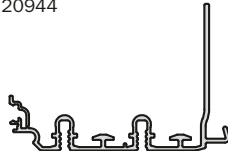

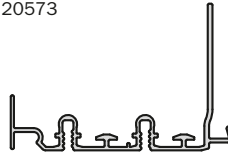
Dans les exemples, sont indiquées les quantités nécessaires pour une armoire ; pour les quantités minimums d'achat, nous vous renvoyons aux tableaux précédents.

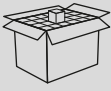

Glow Comment commander un kit pour armoire

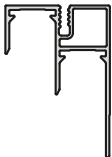

RAILS COULISSANTS

RAIL HAUT STANDARD	L	CODE ARTICLE	 pièces	 Kg	 mm	FIXATION	
	mm						
Prévu pour le cache frontal	6200	VE41PIA16200AB	8	39,0	105 x 115 x 6300	Klik 	21152 
	3100	VE41PTA13100AB	8	19,6	105 x 115 x 3200	Klik 	
Non prévu pour le cache frontal	6200	VE41PIB16200AB	8	39,5	105 x 115 x 6300	Klik 	21151 
	3100	VE41PTB13100AB	8	19,8	105 x 115 x 3200	Klik 	

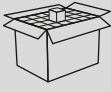
RAIL HAUT RENFORCÉ	L	CODE ARTICLE	 pièces	 Kg	 mm	FIXATION	
	mm						
Prévu pour le cache frontal	6200	VE41PIA26200AB	8	52,4	200 x 130 x 6300	Klik 	20944 
	3100	VE41PTA23100AB	8	26,2	200 x 130 x 3200	Klik 	
Non prévu pour le cache frontal	6200	VE41PIB26200AB	8	52,6	200 x 130 x 6300	Klik 	20573 
	3100	VE41PTB23100AB	8	26,3	200 x 130 x 3200	Klik 	

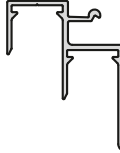

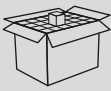

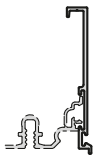
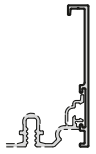

RAIL BAS	L	CODE ARTICLE	 pièces	 Kg	 mm	FIXATION	
	mm						
	6200	VE41PIE16200AB	8	37,0	75 x 190 x 6300		21162 
	3100	VE41PTE13100AB	8	18,5	75 x 190 x 3200		

RAIL BAS	L	CODE ARTICLE	 pièces	 Kg	 mm	FIXATION	
	mm						
	6200	VE41BIX06200AB	8	35,8	235 x 75 x 6300	Klik	39428 
	3100	VE41BTX03100AB	8	17,9	235 x 75 x 3200	Klik	

CACHE FRONTAL	L	CODE ARTICLE	 pièces	 Kg	 mm		
	mm						
Avec rainure pour joint brosse	6200	VE41BIA06200AB	8	15,7	125 x 75 x 6300		34032 
	3100	VE41BTA03100AB	8	7,80	125 x 75 x 3200		
Sans rainure pour joint brosse	6200	VE41BIB06200AB	8	15,02	125 x 75 x 6300		35510 
	3100	VE41BTB03100AB	8	7,50	125 x 75 x 3200		

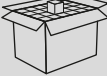



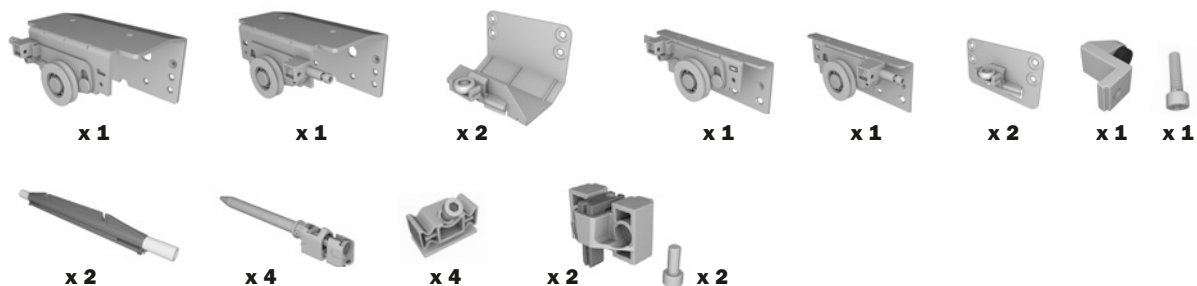

Glow Comment commander un kit pour armoire

2 PORTES AMORTIES (25 KG)

ARTICLE	 mm	 mm	CODE ARTICLE	 pièces	 Kg	 m ³	 mm
Ferrures de coulissement et amortisseurs pour armoire à deux portes	≤ 23	17	VE41KSKACMA2013	1	4,52	0,013	330 x 230 x 170
	≤ 23	33	VE41KSKACMA2513	1	4,54	0,013	330 x 230 x 170
	≤ 26	17	VE41KSKACMA2063	1	4,56	0,013	330 x 230 x 170
	≤ 26	33	VE41KSKACMA2563	1	4,57	0,013	330 x 230 x 170
	≤ 30	17	VE41KSKACMA2023	1	4,59	0,013	330 x 230 x 170
	≤ 30	33	VE41KSKACMA2523	1	4,61	0,013	330 x 230 x 170
	≤ 35	17	VE41KSKACMA2033	1	4,65	0,014	340 x 240 x 175
	≤ 35	33	VE41KSKACMA2533	1	4,67	0,014	340 x 240 x 175
	≤ 40	17	VE41KSKACMA2043	1	4,71	0,014	340 x 240 x 180
	≤ 40	33	VE41KSKACMA2543	1	4,73	0,014	340 x 240 x 180
	≤ 50	17	VE41KSKACMA2053	1	4,89	0,015	340 x 240 x 190
	≤ 50	33	VE41KSKACMA2553	1	4,91	0,015	340 x 240 x 190

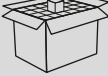





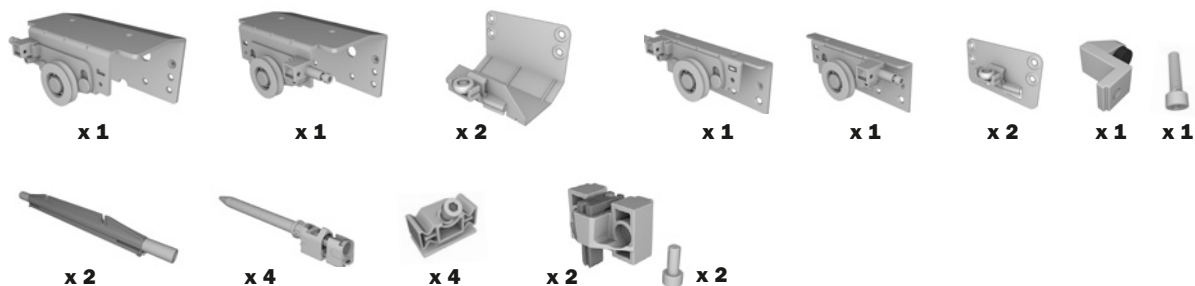

2 PORTES AMORTIES (45 KG)

ARTICLE	 mm	 mm	CODE ARTICLE	 pièces	 Kg	 m ³	 mm
Ferrures de coulissement et amortisseurs pour armoire à deux portes	≤ 23	17	VE41KSKACMA2010	1	4,52	0,013	330 x 230 x 170
	≤ 23	33	VE41KSKACMA2510	1	4,54	0,013	330 x 230 x 170
	≤ 26	17	VE41KSKACMA2060	1	4,56	0,013	330 x 230 x 170
	≤ 26	33	VE41KSKACMA2560	1	4,57	0,013	330 x 230 x 170
	≤ 30	17	VE41KSKACMA2020	1	4,59	0,013	330 x 230 x 170
	≤ 30	33	VE41KSKACMA2520	1	4,61	0,013	330 x 230 x 170
	≤ 35	17	VE41KSKACMA2030	1	4,65	0,014	340 x 240 x 175
	≤ 35	33	VE41KSKACMA2530	1	4,67	0,014	340 x 240 x 175
	≤ 40	17	VE41KSKACMA2040	1	4,71	0,014	340 x 240 x 180
	≤ 40	33	VE41KSKACMA2540	1	4,73	0,014	340 x 240 x 180
	≤ 50	17	VE41KSKACMA2050	1	4,89	0,015	340 x 240 x 190
	≤ 50	33	VE41KSKACMA2550	1	4,91	0,015	340 x 240 x 190



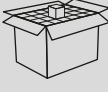



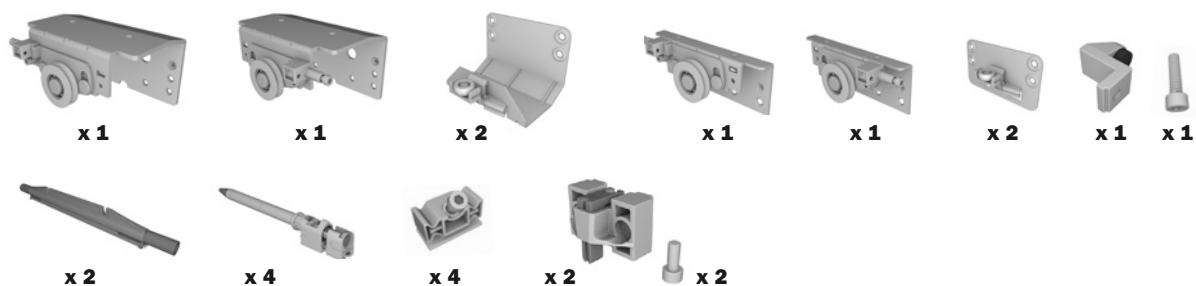

Glow+ Comment commander un kit pour armoire

2 PORTES AMORTIES (70 KG)

ARTICLE			CODE ARTICLE				
	mm	mm		pièces	Kg	m ³	mm
Ferrures de coulissement et amortisseurs pour armoire à deux portes	≤ 23	17	VE41KSKACMA2015	1	4,52	0,013	330 x 230 x 170
	≤ 23	33	VE41KSKACMA2515	1	4,54	0,013	330 x 230 x 170
	≤ 26	17	VE41KSKACMA2065	1	4,56	0,013	330 x 230 x 170
	≤ 26	33	VE41KSKACMA2565	1	4,57	0,013	330 x 230 x 170
	≤ 30	17	VE41KSKACMA2025	1	4,59	0,013	330 x 230 x 170
	≤ 30	33	VE41KSKACMA2525	1	4,61	0,013	330 x 230 x 170
	≤ 35	17	VE41KSKACMA2035	1	4,65	0,014	340 x 240 x 175
	≤ 35	33	VE41KSKACMA2535	1	4,67	0,014	340 x 240 x 175
	≤ 40	17	VE41KSKACMA2045	1	4,71	0,014	340 x 240 x 180
	≤ 40	33	VE41KSKACMA2545	1	4,73	0,014	340 x 240 x 180
	≤ 50	17	VE41KSKACMA2055	1	4,89	0,015	340 x 240 x 190
	≤ 50	33	VE41KSKACMA2555	1	4,91	0,015	340 x 240 x 190





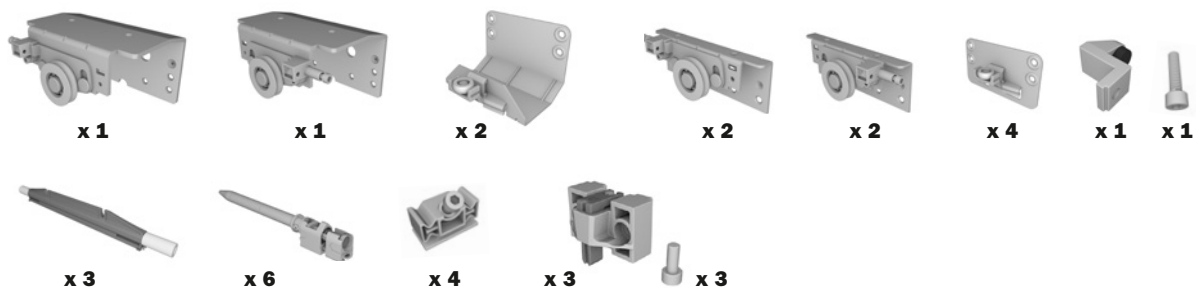

3 PORTES AMORTIES (25 KG)

ARTICLE			CODE ARTICLE				
	mm	mm		pièces	Kg	m ²	mm
Ferrures de coulissement et amortisseurs pour armoire à trois portes	≤ 23	17	VE41KSKACMA3013	1	6,02	0,013	330 x 230 x 170
	≤ 23	33	VE41KSKACMA3513	1	6,06	0,013	330 x 230 x 170
	≤ 26	17	VE41KSKACMA3063	1	6,05	0,013	330 x 230 x 170
	≤ 26	33	VE41KSKACMA3563	1	6,08	0,013	330 x 230 x 170
	≤ 30	17	VE41KSKACMA3023	1	6,09	0,013	330 x 230 x 170
	≤ 30	33	VE41KSKACMA3523	1	6,13	0,013	330 x 230 x 170
	≤ 35	17	VE41KSKACMA3033	1	6,15	0,014	340 x 240 x 175
	≤ 35	33	VE41KSKACMA3533	1	6,19	0,014	340 x 240 x 175
	≤ 40	17	VE41KSKACMA3043	1	6,21	0,014	340 x 240 x 180
	≤ 40	33	VE41KSKACMA3543	1	6,25	0,014	340 x 240 x 180
	≤ 50	17	VE41KSKACMA3053	1	6,39	0,015	340 x 240 x 190
	≤ 50	33	VE41KSKACMA3553	1	6,43	0,015	340 x 240 x 190





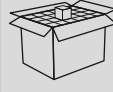

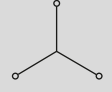

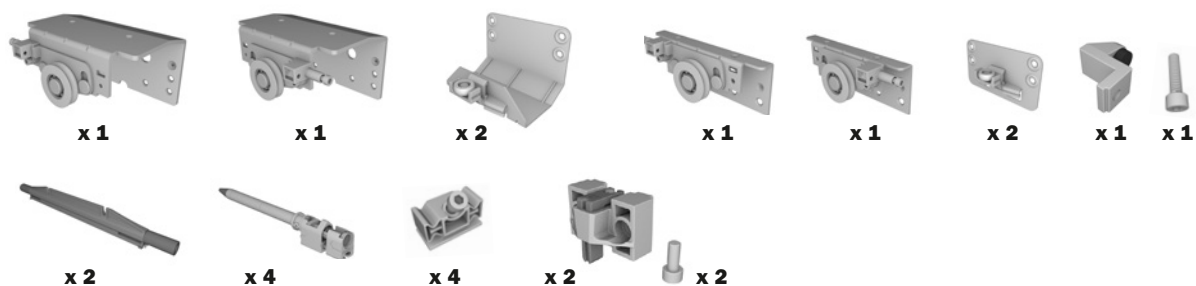
Glow+ Comment commander un kit pour armoire

3 PORTES AMORTIES (45 KG)

ARTICLE	 mm	 mm	CODE ARTICLE	 pièces	 Kg	 m ²	 mm
Ferrures de coulissement et amortisseurs pour armoire à trois portes	≤ 23	17	VE41KSKACMA3010	1	6,02	0,013	330 x 230 x 170
	≤ 23	33	VE41KSKACMA3510	1	6,06	0,013	330 x 230 x 170
	≤ 26	17	VE41KSKACMA3060	1	6,05	0,013	330 x 230 x 170
	≤ 26	33	VE41KSKACMA3560	1	6,08	0,013	330 x 230 x 170
	≤ 30	17	VE41KSKACMA3020	1	6,09	0,013	330 x 230 x 170
	≤ 30	33	VE41KSKACMA3520	1	6,13	0,013	330 x 230 x 170
	≤ 35	17	VE41KSKACMA3030	1	6,15	0,014	340 x 240 x 175
	≤ 35	33	VE41KSKACMA3530	1	6,19	0,014	340 x 240 x 175
	≤ 40	17	VE41KSKACMA3040	1	6,21	0,014	340 x 240 x 180
	≤ 40	33	VE41KSKACMA3540	1	6,25	0,014	340 x 240 x 180
	≤ 50	17	VE41KSKACMA3050	1	6,39	0,015	340 x 240 x 190
	≤ 50	33	VE41KSKACMA3550	1	6,43	0,015	340 x 240 x 190

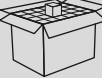





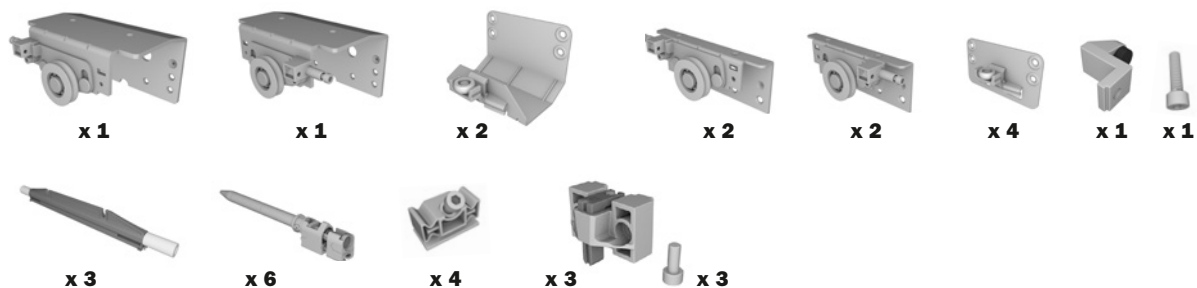

3 PORTES AMORTIES (70 KG)

ARTICLE	 mm	 mm	CODE ARTICLE	 pièces	 Kg	 m³	 mm
Ferrures de coulissement et amortisseurs pour armoire à trois portes	≤ 23	17	VE41KSKACMA3015	1	6,02	0,013	330 x 230 x 170
	≤ 23	33	VE41KSKACMA3515	1	6,06	0,013	330 x 230 x 170
	≤ 26	17	VE41KSKACMA3065	1	6,05	0,013	330 x 230 x 170
	≤ 26	33	VE41KSKACMA3565	1	6,08	0,013	330 x 230 x 170
	≤ 30	17	VE41KSKACMA3025	1	6,09	0,013	330 x 230 x 170
	≤ 30	33	VE41KSKACMA3525	1	6,13	0,013	330 x 230 x 170
	≤ 35	17	VE41KSKACMA3035	1	6,15	0,014	340 x 240 x 175
	≤ 35	33	VE41KSKACMA3535	1	6,19	0,014	340 x 240 x 175
	≤ 40	17	VE41KSKACMA3045	1	6,21	0,014	340 x 240 x 180
	≤ 40	33	VE41KSKACMA3545	1	6,25	0,014	340 x 240 x 180
	≤ 50	17	VE41KSKACMA3055	1	6,39	0,015	340 x 240 x 190
	≤ 50	33	VE41KSKACMA3555	1	6,43	0,015	340 x 240 x 190



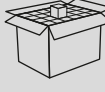





Glow Comment commander un kit pour armoire

2 PORTES NON AMORTIES

ARTICLE	 mm	 mm	CODE ARTICLE	 pièces	 Kg	 m ³	 mm
Ferrures de coulissement et butée finale pour armoire à deux portes	≤ 23	17	VE41KSNACMI2010	1	3,86	0,009	330 x 230 x 120
	≤ 23	33	VE41KSNACMI2510	1	3,88	0,009	330 x 230 x 120
	≤ 26	17	VE41KSNACMI2060	1	3,89	0,009	330 x 230 x 120
	≤ 26	33	VE41KSNACMI2560	1	3,92	0,009	330 x 230 x 120
	≤ 30	17	VE41KSNACMI2020	1	3,93	0,009	330 x 230 x 120
	≤ 30	33	VE41KSNACMI2520	1	3,95	0,009	330 x 230 x 120
	≤ 35	17	VE41KSNACMI2030	1	3,99	0,010	340 x 240 x 125
	≤ 35	33	VE41KSNACMI2530	1	4,01	0,010	340 x 240 x 125
	≤ 40	17	VE41KSNACMI2040	1	4,05	0,011	340 x 240 x 130
	≤ 40	33	VE41KSNACMI2540	1	4,07	0,011	340 x 240 x 130
	≤ 50	17	VE41KSNACMI2050	1	4,23	0,011	340 x 240 x 140
	≤ 50	33	VE41KSNACMI2550	1	4,25	0,011	340 x 240 x 140



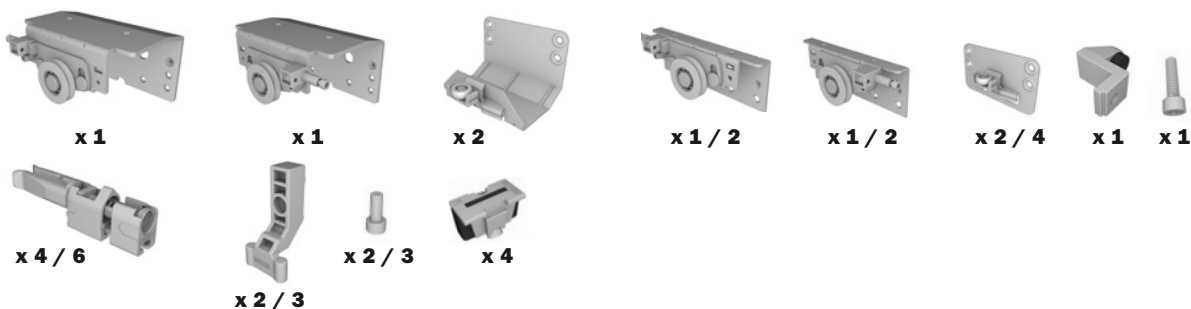

3 PORTES NON AMORTIES

ARTICLE	 mm	 mm	CODE ARTICLE	 pièces	 Kg	 m ³	 mm
Ferrures de coulissement et butée finale pour armoire à trois portes	≤ 23	17	VE41KSNACMI3010	1	4,04	0,009	330 x 230 x 120
	≤ 23	33	VE41KSNACMI3510	1	4,24	0,009	330 x 230 x 120
	≤ 26	17	VE41KSNACMI3060	1	4,06	0,009	330 x 230 x 120
	≤ 26	33	VE41KSNACMI3560	1	4,28	0,009	330 x 230 x 120
	≤ 30	17	VE41KSNACMI3020	1	4,11	0,009	330 x 230 x 120
	≤ 30	33	VE41KSNACMI3520	1	4,31	0,009	330 x 230 x 120
	≤ 35	17	VE41KSNACMI3030	1	4,17	0,010	340 x 240 x 125
	≤ 35	33	VE41KSNACMI3530	1	4,37	0,010	340 x 240 x 125
	≤ 40	17	VE41KSNACMI3040	1	4,23	0,011	340 x 240 x 130
	≤ 40	33	VE41KSNACMI3540	1	4,43	0,011	340 x 240 x 130
	≤ 50	17	VE41KSNACMI3050	1	4,41	0,011	340 x 240 x 140
	≤ 50	33	VE41KSNACMI3550	1	4,61	0,011	340 x 240 x 140



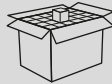

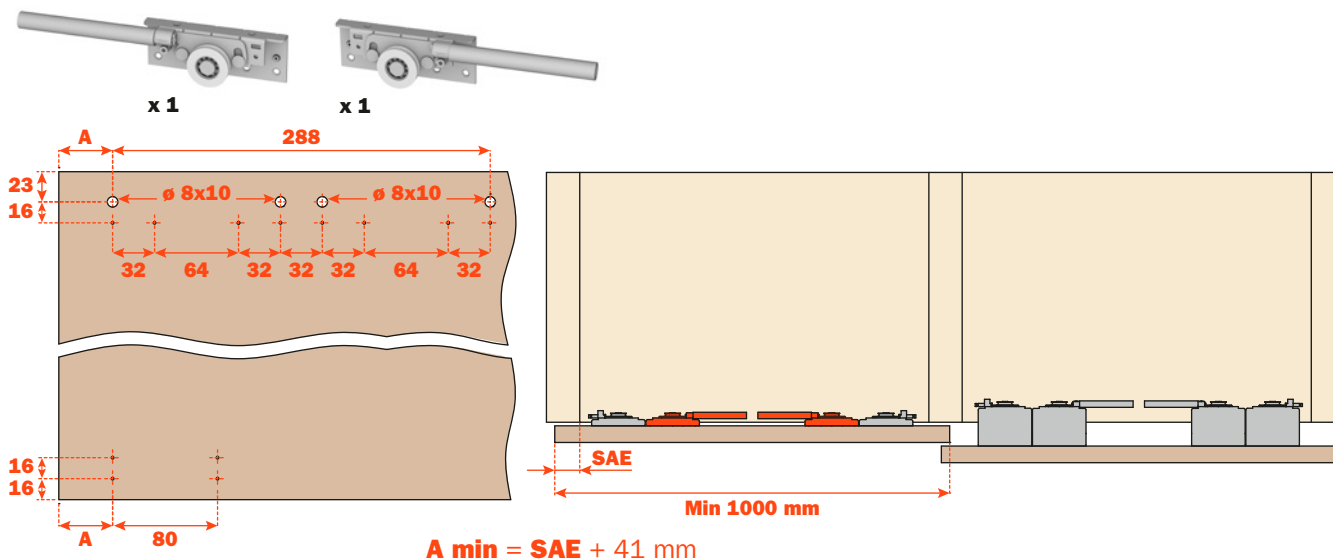

KIT FERRURES 100 KG

Paire de ferrures, à ajouter aux ferrures standards. Cela permet d'augmenter la capacité de charge de la porte jusqu'à 100 kg.

ARTICLE	CODE ARTICLE	 pièces	 Kg	 m ³	 mm
Ferrures de coulissement de porte intérieure	VE41KSKPCMI1A99	1	1,2	0,011	340 x 240 x 136





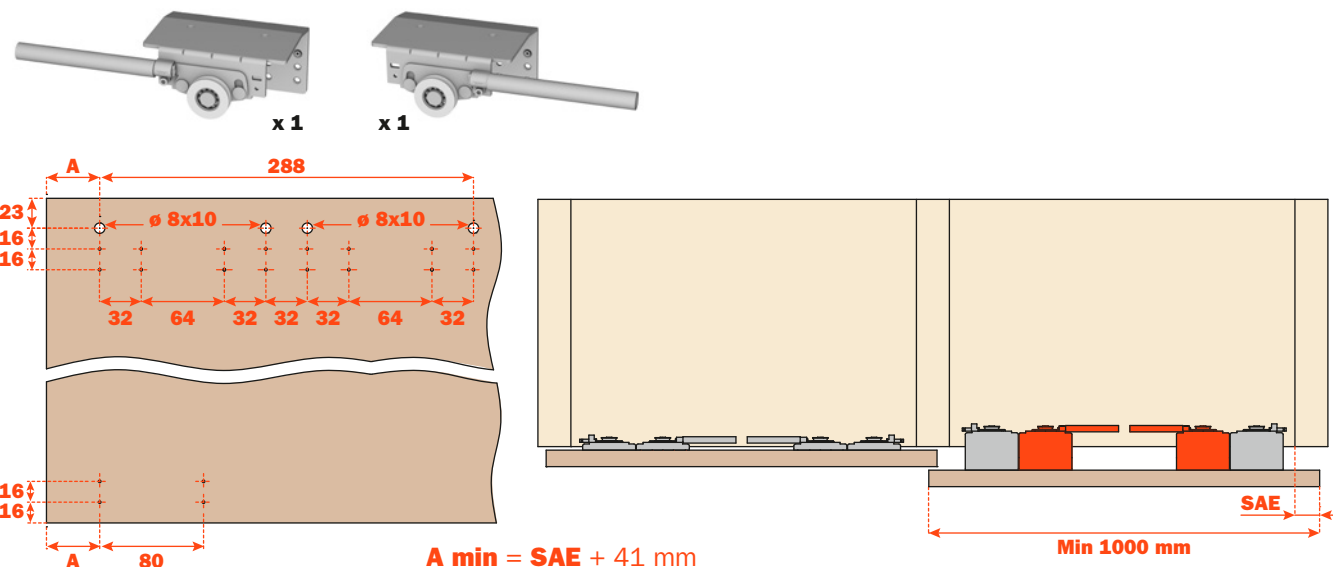

ARTICLE	 mm	CODE ARTICLE	 pièces	 Kg	 m ³	 mm
Ferrures de coulissement de porte extérieure	23	VE41KSKPCMI1A19	1	2,2	0,011	340 x 240 x 136
	26	VE41KSKPCMI1A69	1	2,3	0,011	340 x 240 x 136
	30	VE41KSKPCMI1A29	1	2,3	0,011	340 x 240 x 136
	35	VE41KSKPCMI1A39	1	2,4	0,011	340 x 240 x 136
	40	VE41KSKPCMI1A49	1	2,5	0,011	340 x 240 x 136
	50	VE41KSKPCMI1A59	1	2,6	0,011	340 x 240 x 136



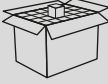

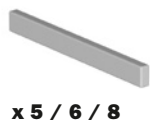
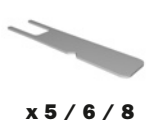

Glow Comment commander un kit pour armoire

KIT ACCESSOIRES POUR CACHE FRONTAL

ARTICLE	L	CODE ARTICLE	 pièces	 Kg	 m ³	 mm
	mm					
Kit avec aimants, contreplaques et joint brosse	≤ 2000	VE41KSM0S05	1	0,10	-	120 x 80 x 4
	≤ 3000	VE41KSM0S06	1	0,12	-	120 x 80 x 4
	≤ 4000	VE41KSM0S07	1	0,14	-	120 x 80 x 4



KIT CLIP

ARTICLE		CODE ARTICLE	 pièces	 Kg	 m ³	 mm
Kit 6 clips avec applicateur		VE41KSCCLIP6	1	0,26	-	-
Kit 9 clips avec applicateur		VE41KSCCLIP9	1	0,37	-	-

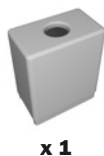



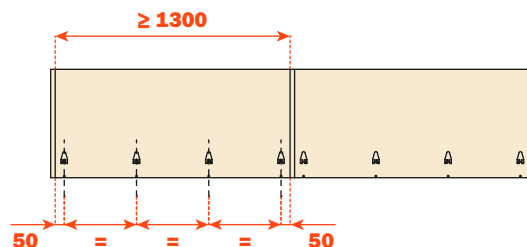
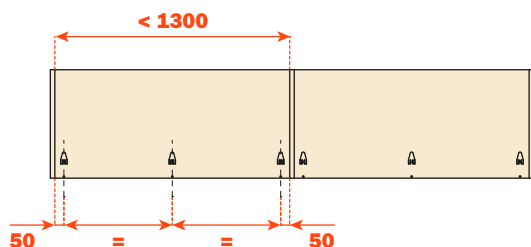

Klik



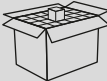

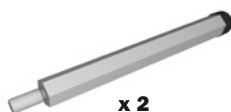

KIT AXES ANTI-COLLISION

Pour les armoires à 3 portes, vous pouvez commander les tiges anti-collision à appliquer aux portes intérieures (1 kit de 2 pièces).

ARTICLE	CODE ARTICLE	 pièces	 Kg	 m ³	 mm
Tiges anticollision	VE41KMGLW510C	1	0,05	-	-

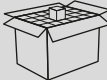

CACHE ANTI-POUSSIÈRE AVEC VELCRO AUTOCOLLANT

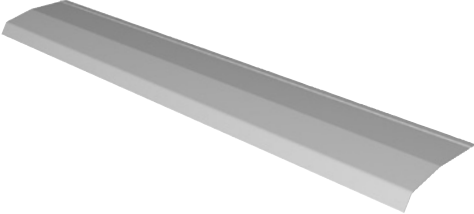
ARTICLE	L	CODE ARTICLE	 pièces	 Kg	 m ³	 mm
	mm					
Caches chariots de porte extérieure 	600	VE41CSVS00600A	1	0,31	0,003	900 x 110 x 30
	700	VE41CSVS00700A	1	0,33	0,003	900 x 110 x 30
	800	VE41CSVS00800A	1	0,35	0,003	900 x 110 x 30
	900	VE41CSVS00900A	1	0,38	0,003	900 x 110 x 30
	1000	VE41CSVS01000A	1	0,45	0,004	1200 x 110 x 30
	1100	VE41CSVS01100A	1	0,48	0,004	1200 x 110 x 30
	1200	VE41CSVS01200A	1	0,50	0,004	1200 x 110 x 30
	1300	VE41CSVS01300A	1	0,52	0,005	1500 x 110 x 30
	1400	VE41CSVS01400A	1	0,55	0,005	1500 x 110 x 30
	1500	VE41CSVS01500A	1	0,63	0,006	1500 x 110 x 30
	1600	VE41CSVS01600A	1	0,66	0,006	2000 x 110 x 30
	1700	VE41CSVS01700A	1	0,68	0,006	2000 x 110 x 30
	1800	VE41CSVS01800A	1	0,70	0,006	2000 x 110 x 30
	1900	VE41CSVS01900A	1	0,72	0,006	2000 x 110 x 30
2000	VE41CSVS02000A	1	0,85	0,006	2000 x 110 x 30	

Glow Comment commander un kit pour armoire

EXEMPLE DE COMMANDE

Exemple 1

Armoire 2 portes (70 kg) de 900 mm, épaisseur 30 mm, H du sol 17 mm, rail standard, amortisseur, cache frontal avec joint brosse, rails de 3100 mm de longueur.

1 x VE41PTA13100AB	1 x VE41PTA13100AB
1 x VE41PTE13100AB	1 x VE41PTE13100AB
1 x VE41BTA03100AB	1 x VE41BTA03100AB
	1 x VE41KSM0S05
	1 x VE41CSVS00900A
	1 x VE41KSKACMA2025

Exemple 2

Armoire 3 portes (45 kg) de 1200 mm, épaisseur 35 mm, H du sol 33 mm, rail renforcé, amortisseur, cache frontal avec joint brosse, rails de 6200 mm de longueur.

1 x VE41PIA26200AB	1 x VE41KSM0S07
1 x VE41PIE16200AB	1 x VE41CSVS01200A
1 x VE41BIA06200AB	1 x VE41KSKACMA3530

Exemple 3

Armoire 3 portes de 1200 mm, épaisseur 50 mm, H du sol 33 mm, avec rail standard, sans amortisseur et cache frontal sans brosse, profils de 6200 mm de longueur.

1 x VE41PIA16200AB	1 x VE41KSM0S07
1 x VE41BIA06200AB	1 x VE41CSVS01200A
1 x VE41BIB06200AB	1 x VE41KSNACMI3550

Dans les exemples, sont indiquées les quantités nécessaires pour une armoire ; pour les quantités minimums d'achat, nous vous renvoyons aux tableaux précédents.

Montage des ferrures de coulissement

PORTES INTERIEURES

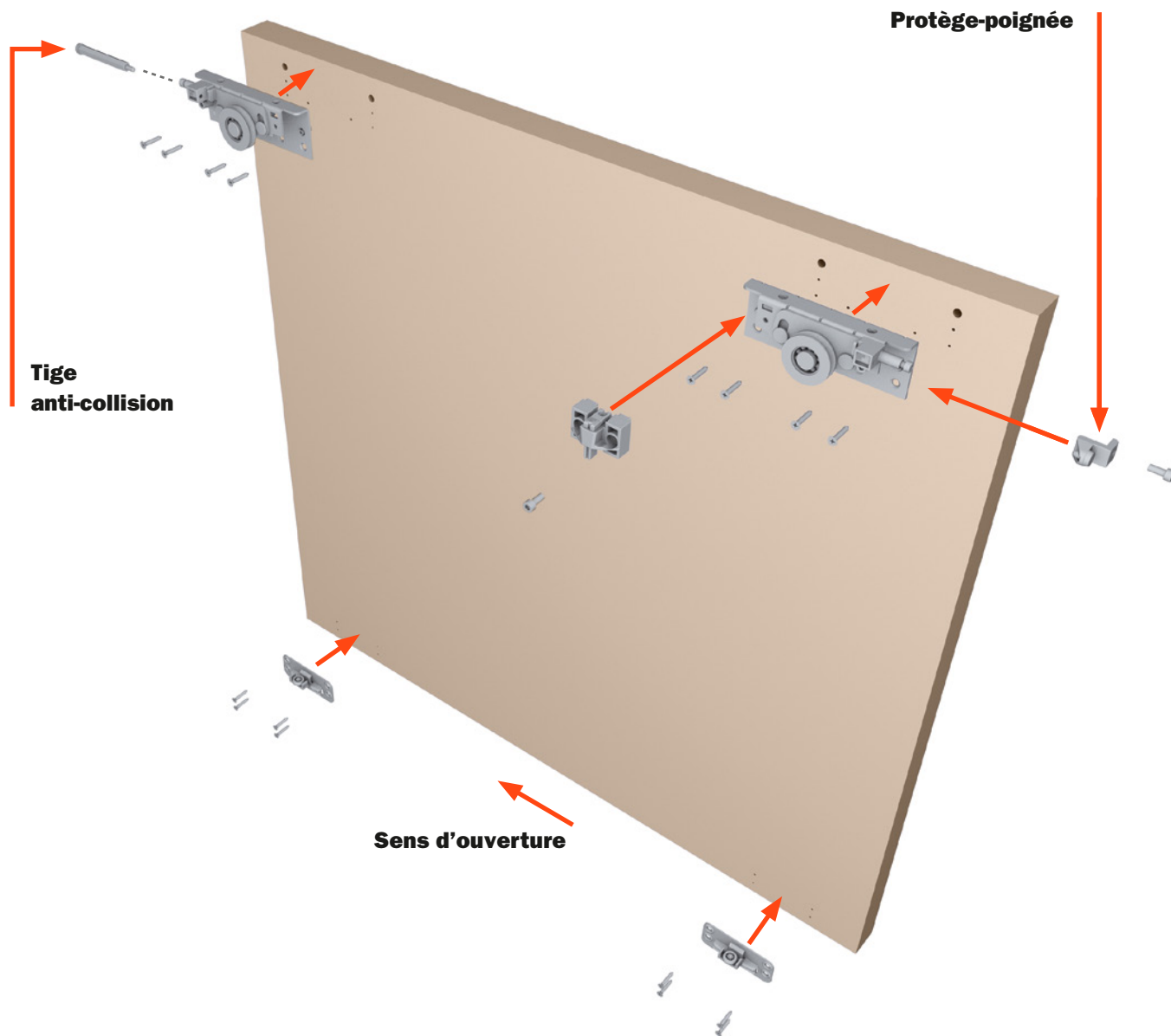

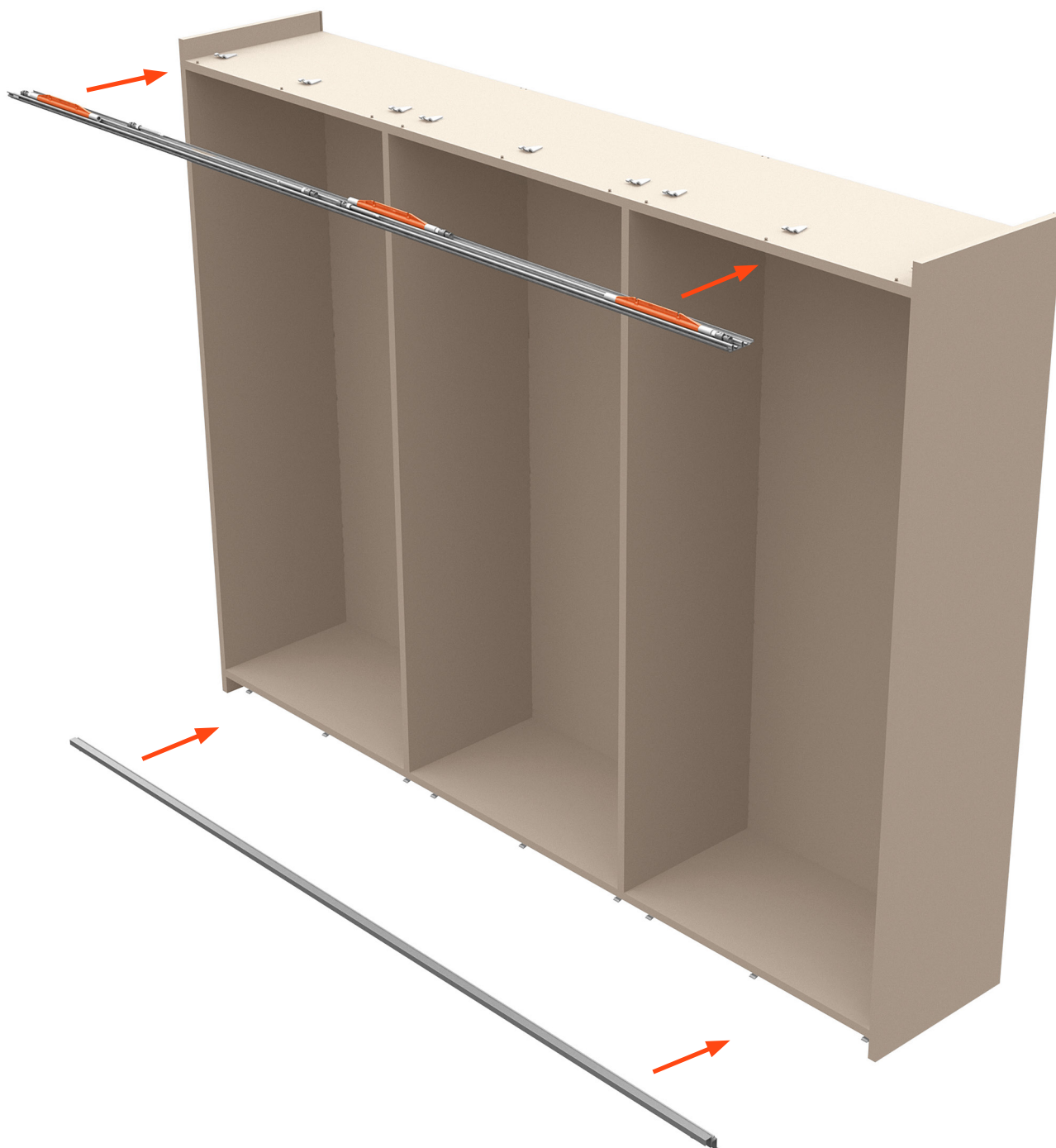
Montage du mécanisme**BREVETS**

Brevet déposé auprès du Ministère des Activités de Production au Bureau Italien des Brevets et Marques (U.I.B.M.).

ARTURO SALICE S.p.A.

VIA PROVINCIALE NOVEDRATESE, 10
22060 NOVEDRATE (COMO) ITALIA
TEL. 031 790424 - FAX 031 791508
info.salice@salice.com - www.salice.com

DEUTSCHE SALICE GMBH

RUDOLF DIESEL STR. 10
POSTFACH 1154
74382 NECKARWESTHEIM
TEL. 07233 9807-0
FAX. 07233 9807-16
info.salice@deutschesalice.de
www.salice.com

DEUTSCHE SALICE GMBH

VERKAUFSBÜRO NORD
RINGSTRASSE 36/A30 CENTER
32584 LÖHNE
TEL. 05731 15608-0
FAX. 05731 15608-10
vknord@deutschesalice.de
www.salice.com

SALICE UK LTD.

KINGFISHER WAY
HINCHINGBROOKE BUSINESS PARK
HUNTINGDON CAMBS PE 29 6FN
TEL. 01480 413831
FAX. 01480 451489
info.salice@saliceuk.co.uk
www.salice.com

BORTOLUZZI SISTEMI S.p.A.

VIA CADUTI 14 SETTEMBRE 1944, 45
32100 BELLUNO ITALIA
TEL. 0437 930866 - FAX 0437 931442
info@bortoluzzi.com - www.bortoluzzi.com

SALICE FRANCE S.A.R.L.

ROUTE DE GOA ZAC LES 3 MOULINS
06600 ANTIBES
TEL. 0493 330069
FAX. 0493 330141
info.salice@salicefrance.com
www.salice.com

SALICE ESPAÑA, S.L.U.

CALLE COPÉRNICO, 11
POLÍGONO INDUSTRIAL COLL DE LA MANYA
08403 GRANOLLERS (BARCELONA)
TEL. 938 45 88 61
FAX 938 49 11 97
info.salice@saliceespana.es
www.salice.com

SALICE PORTUGAL UNIP. LDA

VIA ROTA DOS MÓVEIS I n.399
4585-325 GANDRA-PAREDES (DISTRITO PORTO)
TEL. 00351 224 154 221
info@saliceportugal.pt
www.salice.com

SALICE CHINA (SHANGHAI) CO. LTD.

1st FLOOR, B1 BLDG 928 MINGZHU ROAD
XUJING, QINGPU DISTRICT
SHANGHAI 201702 - CHINA
TEL. 021 3988 9880
FAX. 021 3988 9882
info.salice@salicechina.com
www.salicechina.com

SALICE INDIA PVT. LTD.

1001 & 1002, 10TH FLOOR,
CENTRUM, PLOT NO. C-3,
OPP. WAGLE PRABHAG SAMITI OFFICE,
MIDC AREA, WAGLE INDUSTRIAL ESTATE,
THANE - 400604, MAHARASHTRA
TEL. 022 20812050
info@saliceindia.com
www.salice.com

SALICE CANADA INC.

3500 RIDGEWAY DRIVE,
UNIT#1
MISSISSAUGA, ONTARIO, L5L 0B4
TEL. 905 8208787
FAX. 905 8207226
info.salice@salicecanada.com
www.salicecanada.com

SALICE AMERICA INC.

2123 CROWN CENTRE DRIVE
CHARLOTTE NC. 28227
TEL. 704 8417810
FAX. 704 8417808
info.salice@saliceamerica.com
www.saliceamerica.com



Contenus digitaux

Nous nous réservons le droit de modifier les spécificités techniques.



DOCASS004FRA Ed. 04 - 12/2021